

# Servis karta

Name **BARCELONA**

Typ **T 10 - VITRINA L**

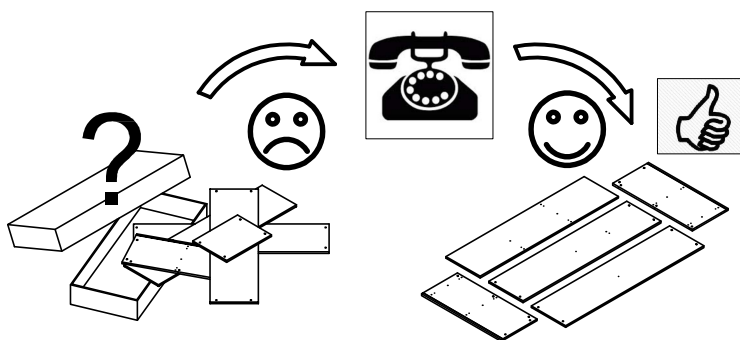
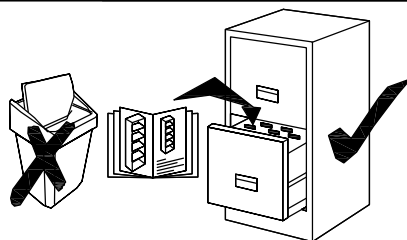

- ① 502×372×38
- ② 416×330×25
- ③ 462×352×29
- ④ 502×372×28
- ⑤a 1934×352×19
- ⑥ 1934×352×19
- ⑦ 462×320×18
- ⑧ 460×290×18
- ⑨ 452×300×6
- ⑩a 668×495×20
- ⑪ 989×458×4
- ⑫a 332×495×20
- ⑬ 1921×478×3
- ⑭ 460×997×4
- ⑮ 60×60×15
- ⑯ 989×160×4

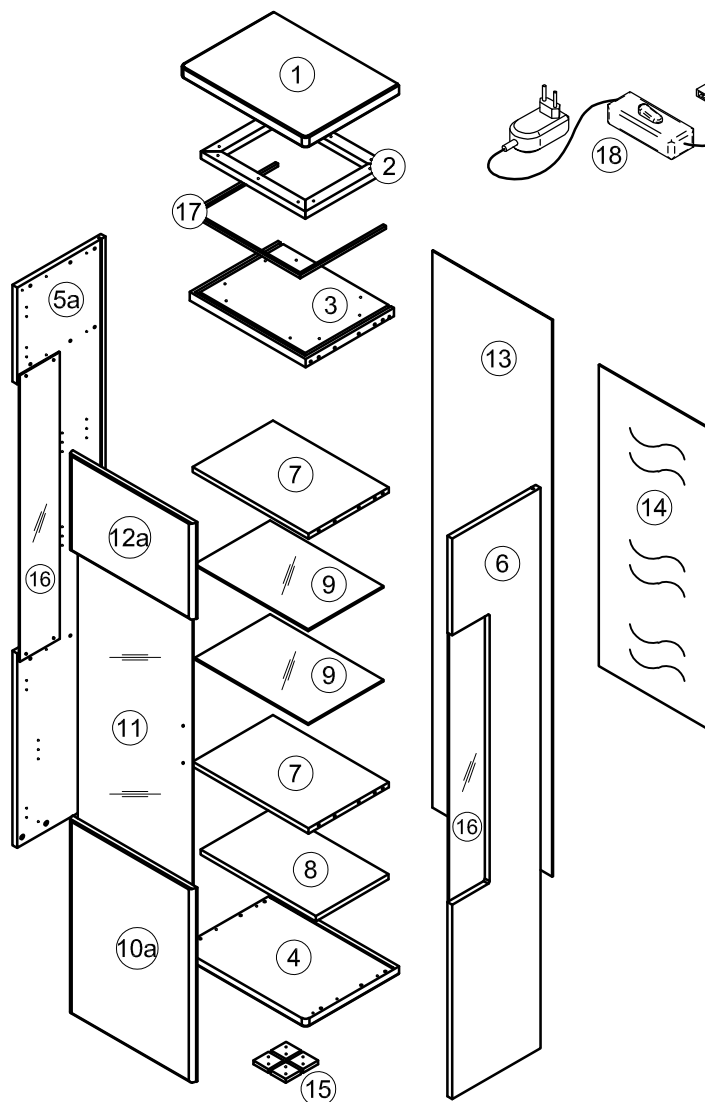
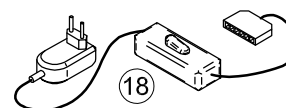

- ⑰ 440×342×342  
**rasvjeta!!**

## OPCIONALNO

005062ZB_BEL.	005062ZB_TRAFO	005091ZB
x1	x1	x1

<b>D1</b> Ø8x32 mm 	<b>S1-16</b> 3x16 mm 	<b>S2-35</b> 4x35mm 	<b>A2</b> 60x20x15 mm 	<b>PC</b> Ø7/9x4mm 	<b>S2-40</b> 4x40mm 
<b>EX</b> Ø15x12 mm 	<b>W1</b> 	<b>S2-16L</b> 4x16 mm 	<b>S2-30</b> 4x30 mm 	<b>GH</b> LAMA 	<b>P1</b> 
<b>T1</b> 	<b>B</b> 	<b>S-16</b> 3,5x16 mm 	<b>W4</b> 	<b>C2</b> 	<b>M10</b> M4x10 mm 
<b>GL</b> 	<b>ST</b> 	<b>PG</b> 128 mm 	<b>H1</b> 0mm 	<b>M1</b> 	<b>ES</b> 6,3x13mm 

# BARCELONA

## UPUTA ZA MONTAŽU TIP 10 - VITRINA L

# 1/2

31.08.2021.



1 osoba

20  
Min.

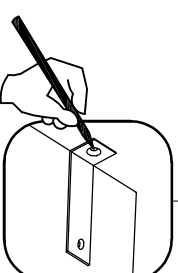
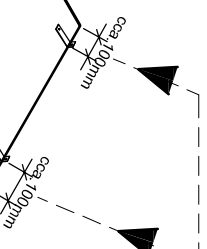
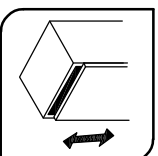
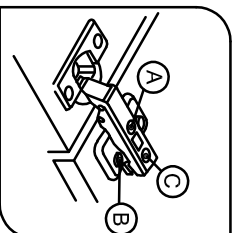
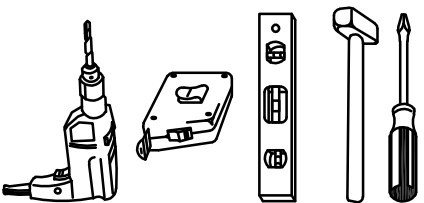

1.

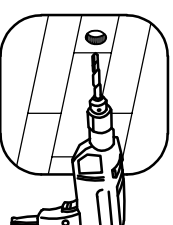

2.

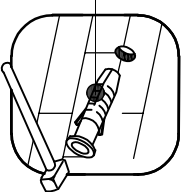

3.

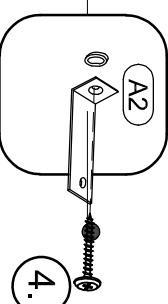

4.

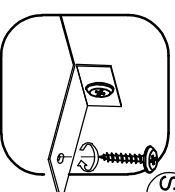

5.

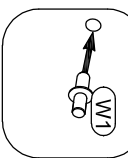
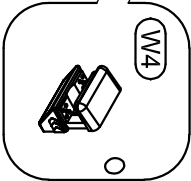
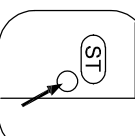
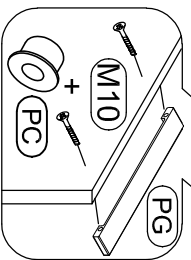

- (M10) M4x10 mm x 2
- (W1) x 4
- (ST) x 2

- (S2-16L) 4x16 mm x 2
- (PG) 128 mm x 1

- (W4) x 8
- (A2) 60x20x15 mm x 2

- (C2) x 20
- (PC) Ø7/9x4mm x 2



# BARCELONA

TIP 10 - VITRINA L

31.08.2021.

1/1

Ovaj simbol označava da ovaj element sadrži elektronske i elektroničke dijelove koje nije dozvoljeno odlagati u običan kućni otpad. Molimo sve elektroničke/elektronske dijelove odlagati u za to predviđeno mjesto!

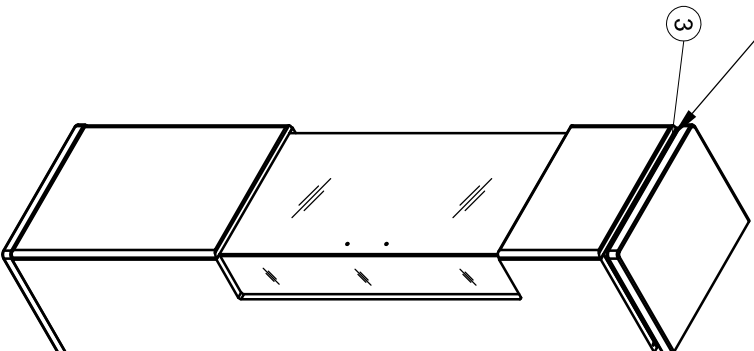
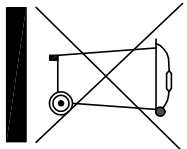

**Paznja:**

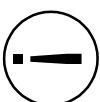

*rasvijetali!*

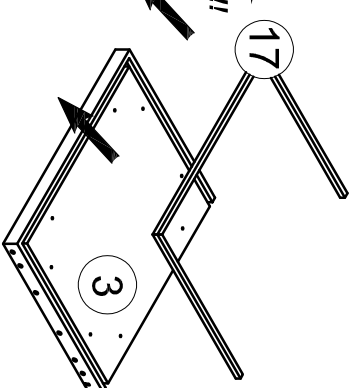

# BARCELONA

TIP 10 - VITRINA L



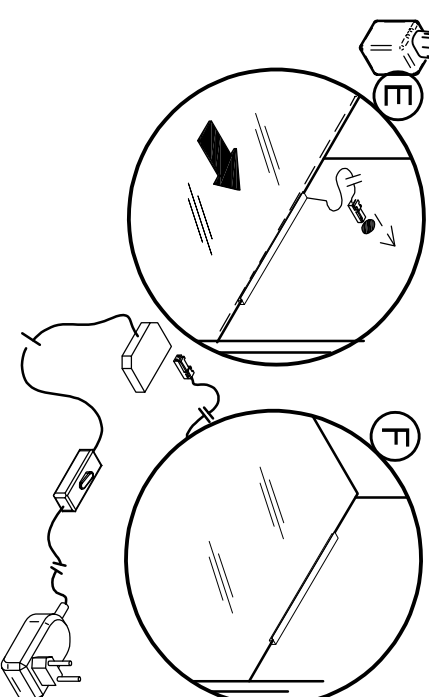
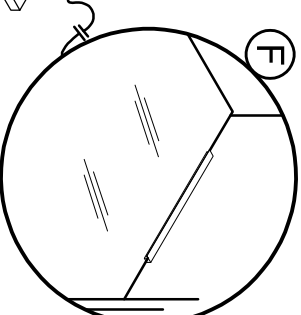
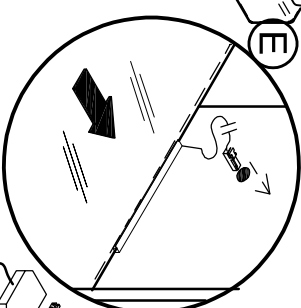
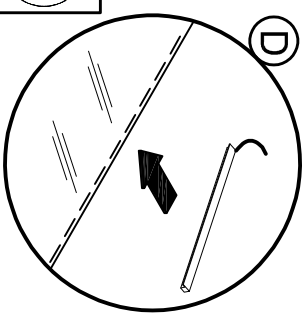
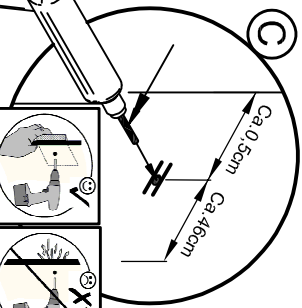
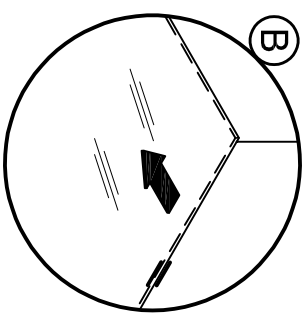
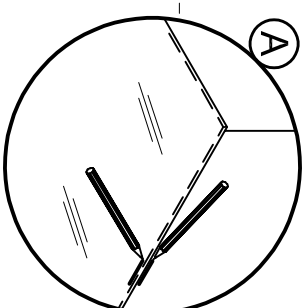
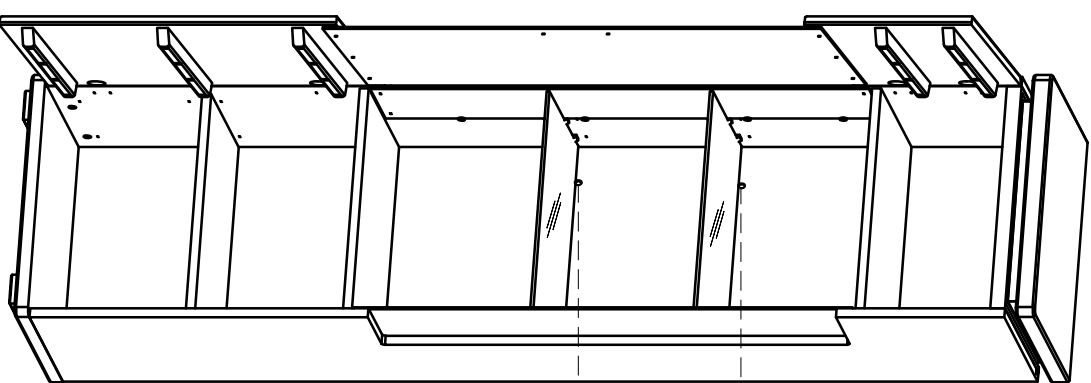
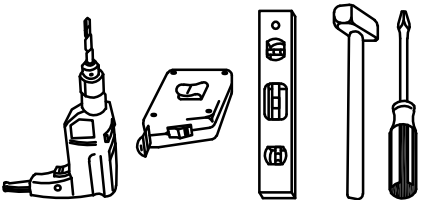

1 osoba

20  
Min.



## OPCIONALNO

005062ZB\_BEL. 005062ZB\_TRAFO 005091ZB

		
X1	X1	X1